

# The Micklethwaites of South West Yorkshire and beyond!

This study started looking into the Micklethwaite strongholds of Mirfield, Kirkburton and Kirkheaton, in an attempt to find out about my 3x great grandfather John (a1 p2.2). This is still "work in progress", especially regarding the Penistone area where there are too many Johns and Jonathans!

Obviously the study now extends beyond those areas, but other sites should be visited for the other areas, namely:

[www.micklethwait.org](http://www.micklethwait.org) - Ingbirchworth, Barnsley and points South and East

[www.hilarymaryjackson.pwp.blueyonder.co.uk/Micklethwaite.htm](http://www.hilarymaryjackson.pwp.blueyonder.co.uk/Micklethwaite.htm) - Bolsterstone

## Index

p1.1	Mirfield and Kirkheaton	p2.0	Barnsley
p1.2	Mirfield, Elland & Wakefield - Hopton Hall	p2.1	Barnsley, Manchester
p1.3	Dalton (Kirkheaton), Lepton, Kirkburton	p2.2	Paddock, Others
p1.4	Kirkheaton and Hopton	p2.3	Kirkburton and Fulstone
p1.5	Cumberworth and High Hoyland	p2.4	Emley
p1.6	Denby and Penistone	p2.5	Thornhill and Campsall/Alverthorpe
p1.7	Sheffield, and more Denby, Penistone	p2.6	Denby, Stalybridge, Saddleworth
p1.8	Ingbirchworth	p2.7	Emley, Alverthorpe and Thornhill
		p2.8	Worsborough, Hemsworth

v2.35 21st May 2009 © 2004-9 Andy Micklethwaite

With grateful thanks to John Micklethwait, Barbara and Liz Parker, Jane Coop, Geoff Phillipson, Mel Smith, Roland Haigh, Doreen Mallinson, Mary Thewlis, Steve Liversidge, Sue Skinner, Doreen Ross, David Andrews, Gill, Anothony and Christopher Micklethwaite and anyone else I've inadvertently forgotten

Additional sources: Census, Parish Registers, NBI, BVRI, IGI batches, BMD

***Whilst all of the data behind these trees is good, much of the linking is based on conjecture. I'm also rather prone to making transcription mistakes - if you think I am wrong, please do tell me! If you think I'm right, please tell me too - I'd love to hear from you if you're researching these folks! I have largely avoided putting data on after 1901, but if you would like me to include yours, do let me know. I have also started a DNA study and would like to hear from living male Micklethwait(e) descendants who are happy to have a DNA test - see: <http://www.ancestryhost.org/andymick/dna.htm>***

I have created a page to honour WW1 Micklethwaite deaths at <http://www.ancestryhost.org/andymick/rollofhonour.htm> they are marked WW1

**[andy\(dot\)mick\(at\)googlemail\(dot\)com](mailto:andy(dot)mick(at)googlemail(dot)com)**

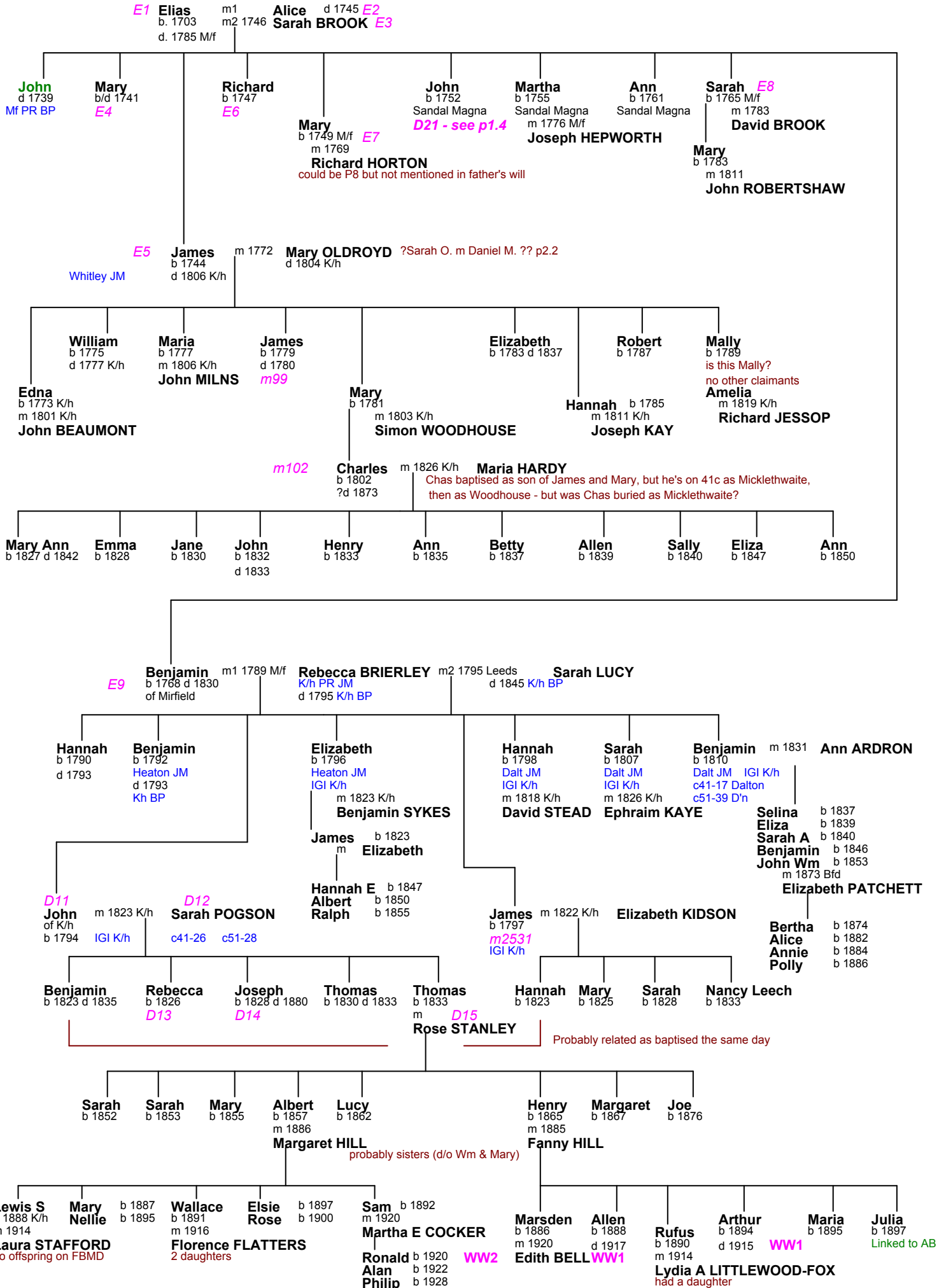

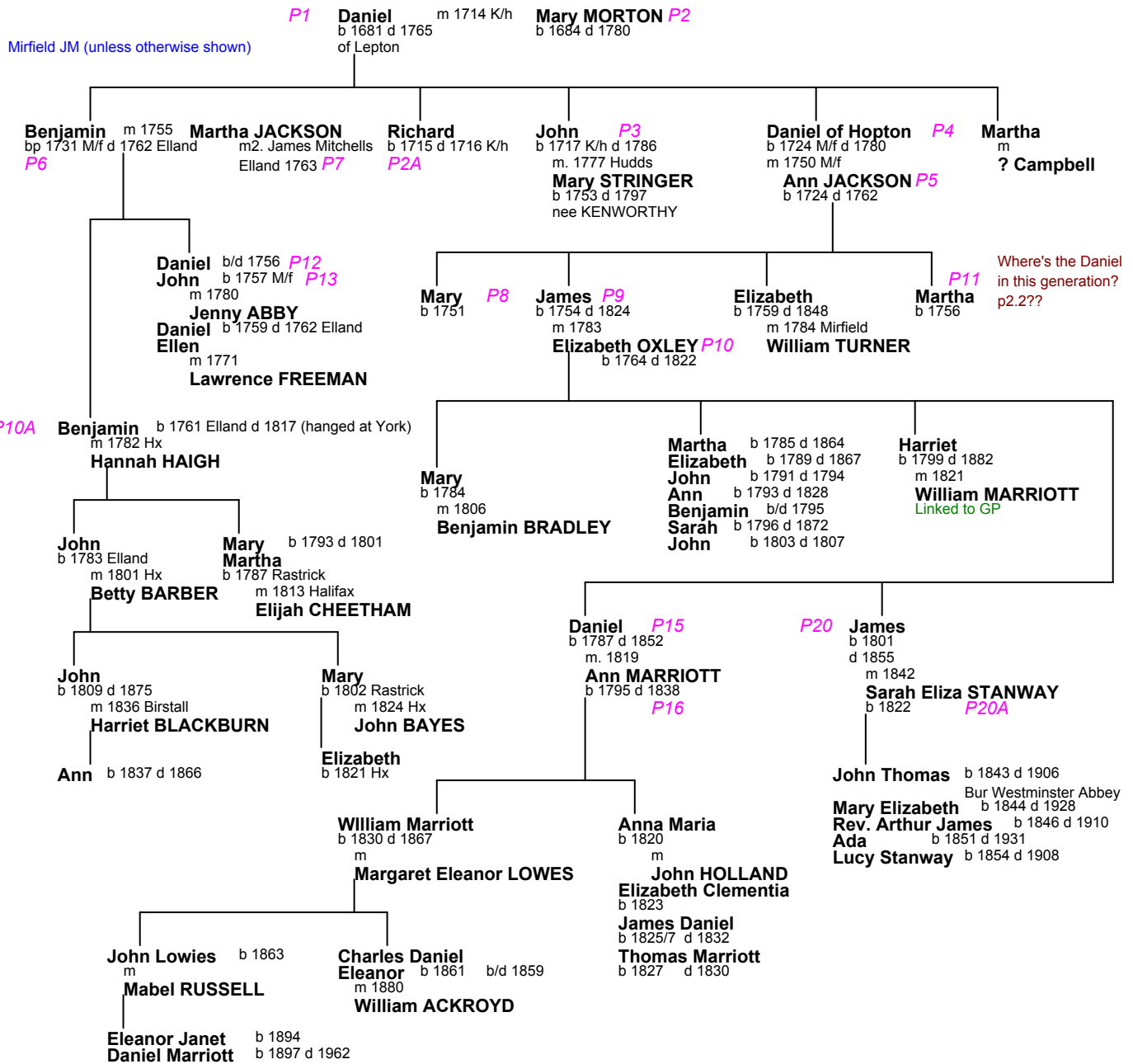

Mirfield IGI

J7 see page 1.3

**John** d 1785 prob. m 1779 M/f of Liley

**Sarah CROSLAND** m2. 1789

**John COPLEY** Linked to MS  
It is also possible John Copley married Sarah nee Oldroyd widow of Daniel p2.2

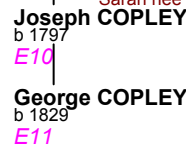
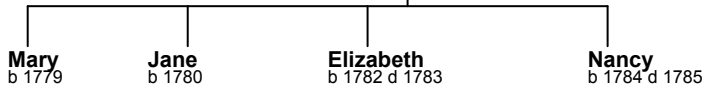

There are 2 sets of children born to Johns:  
imm. above with Sarah Crosland in Mirfield;  
John D21 (m. Mary Cliffe p1.4) in K/h.  
There are now 2 Johns as suitable candidates:  
J7 son of Jonas (p1.2);  
John 1752 son of Elias p1.1.  
As John above was of Liley and Jonas J1 died in Liley the balance of probabilities suggests the one above is J7, so D21 is son of Elias

Ones that don't fit from Mirfield

Which is dau. J1?? Where are the others?  
**Hannah** m 1783 **John TORDOFF**  
**Hannah** m 1788 **James PEACE**  
**Hannah** m 1799 **David BROADLEY**  
Hannah m. BROADLEY is probably dau. of John D21 and Mary Cliffe p1.4, as he appears as witness to other marriages in that tree - still no trace of her baptism

**Elizabeth** m 1828 **Thomas PHILLIPS**  
**Hannah** m 1830 **William HALL**

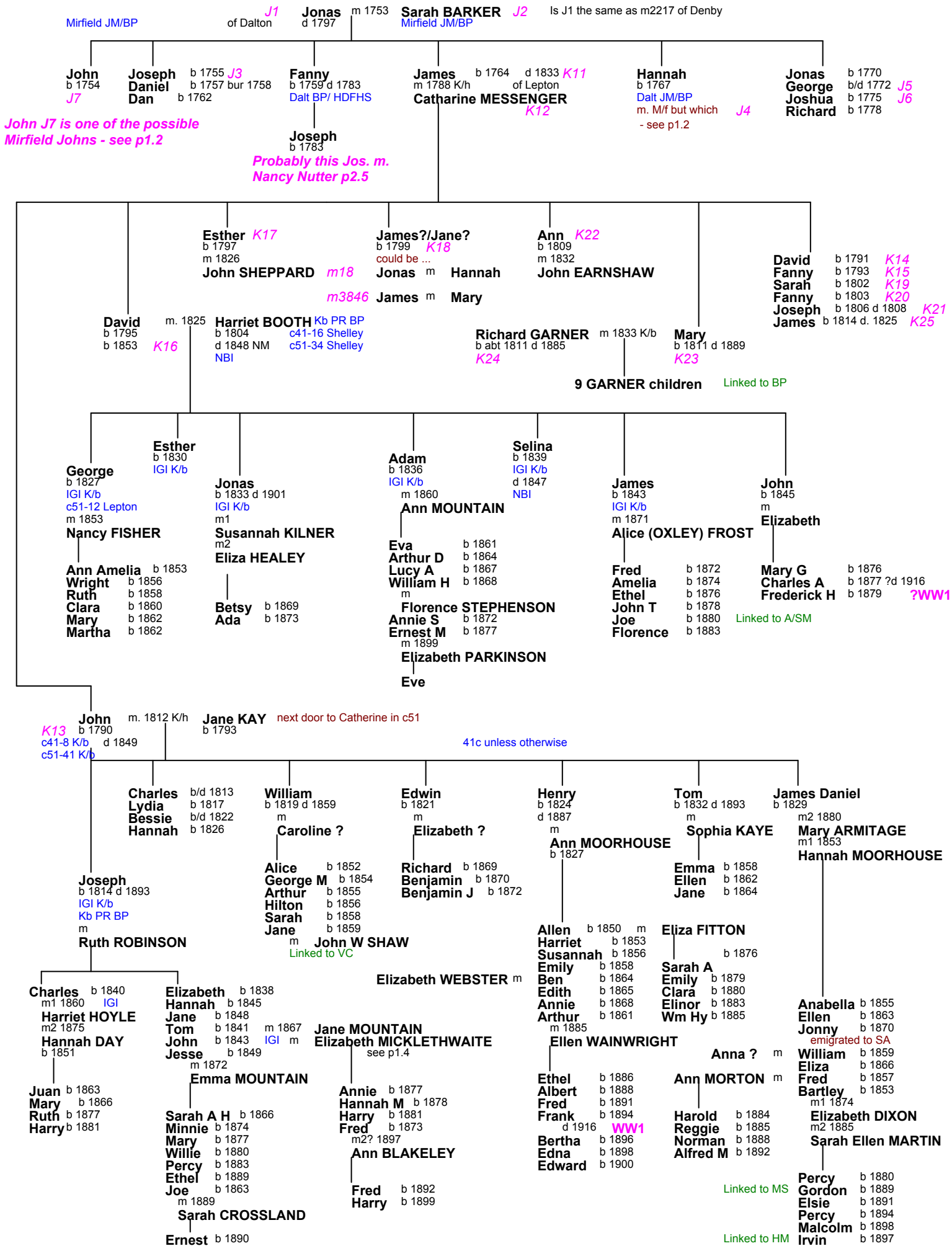

This Daniel is the only reasonable candidate for the Daniel of Flockton and Hopton

John of K/h m 1775 K/h but res M/f D21  
Mary CLIFF Possibly  
son of Elias E1 see page 1.1 - see note on Johns p1.2

K/heaton JM ...>

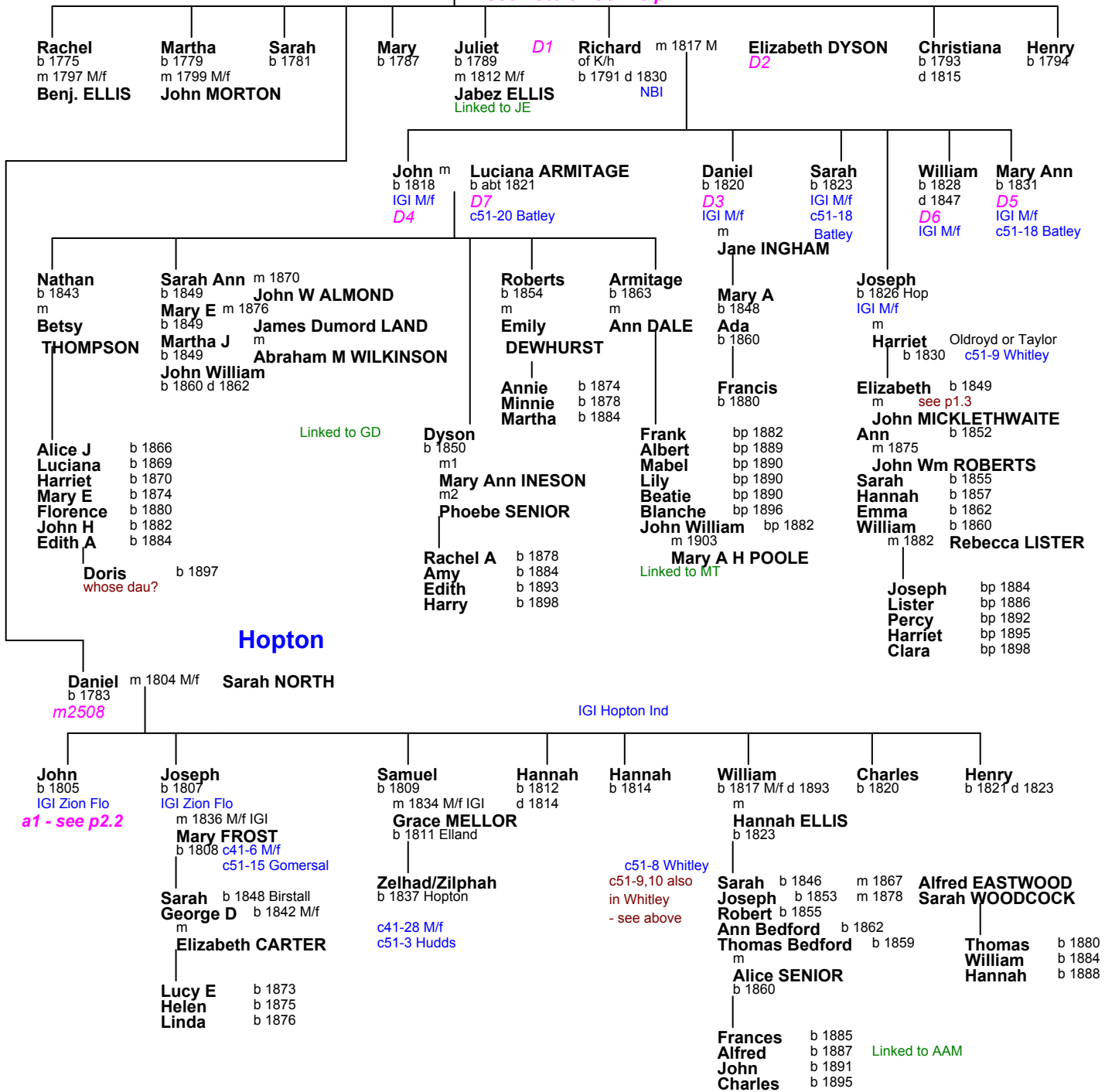

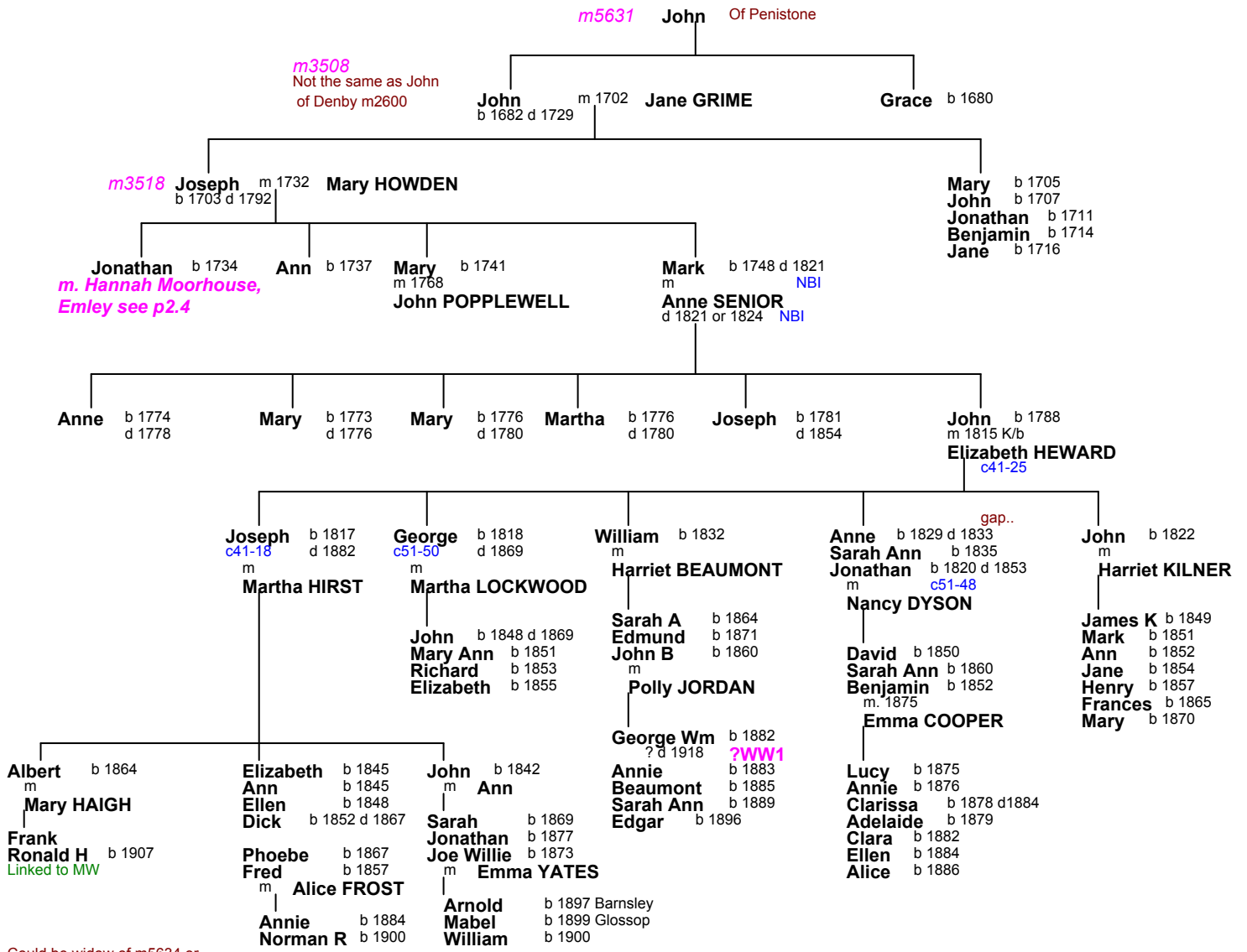

Could be widow of m5634 or their daughter - see page 1.6.

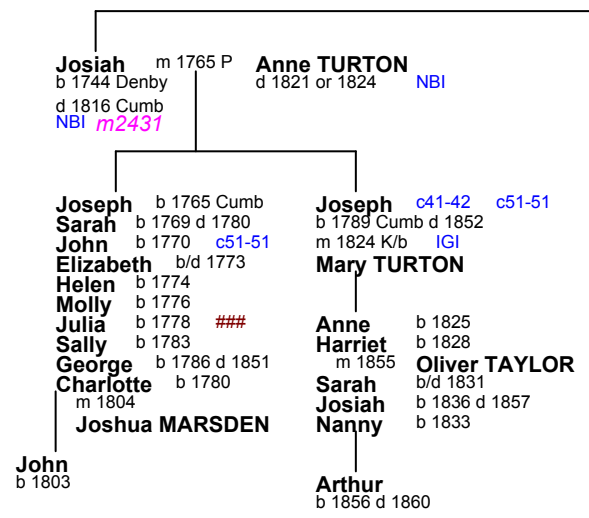
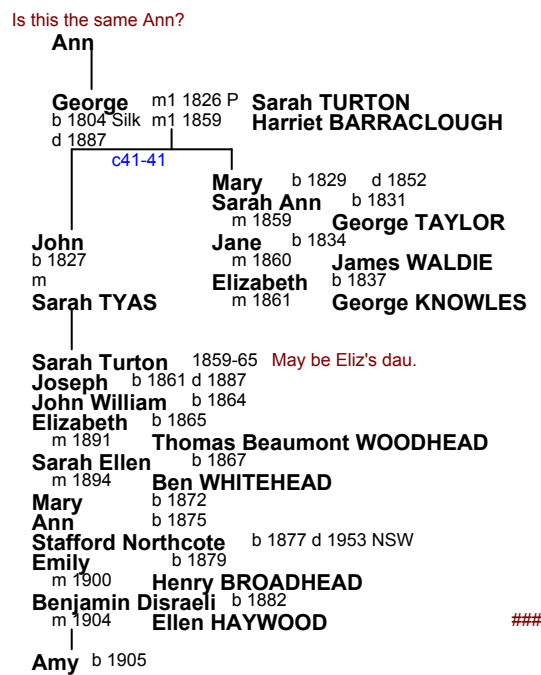
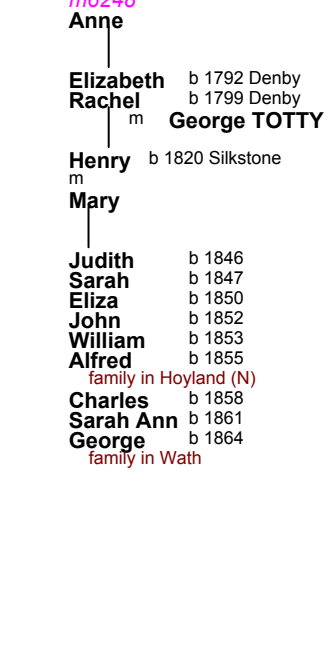

### Which Julia married William TYAS - above or p1.6

High Hoyland

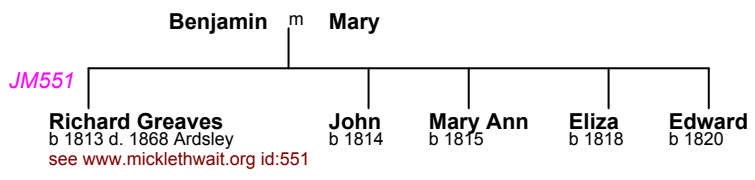

Oddments

- John** m 1626 Cumb
- Mary** m 1684 Cumb
- Jonathan** m 1717 Cumb
- Sarah** m 1814 Cumb
- Martha** b abt 1820
- Harriet** b 1830
- Dionis MARRIOTT**
- Joseph CROSLAND**
- Elizabeth PEACE**
- Thomas KILNER**
- c41-20*

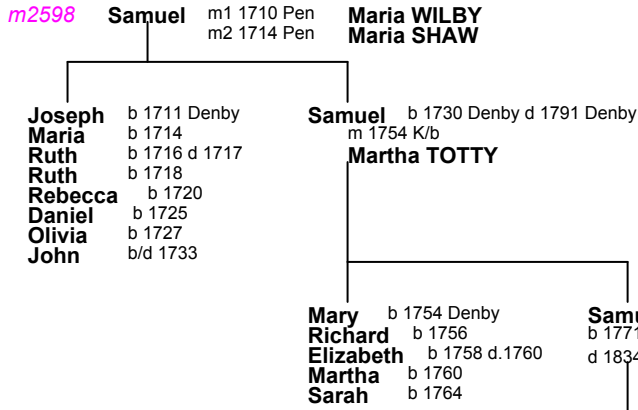

see K/b p2.3

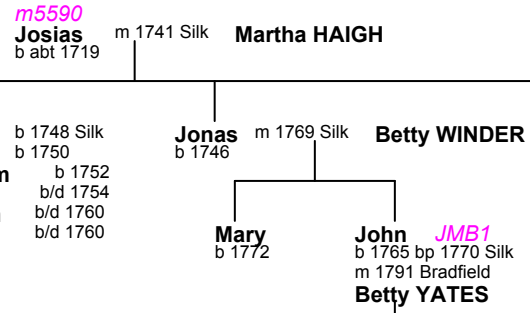

the Bolsterstone branch:-  
www.hilarymaryjackson.pwp.blueyonder.co.uk/Micklethwaite.htm  
Linked to CG/HJ

The will of John of Ingbirchworth (JM1027B p1.7) 1732 names Jenkinson, Elizabeth and Penelope - there is at least another John - this one has the other offspring

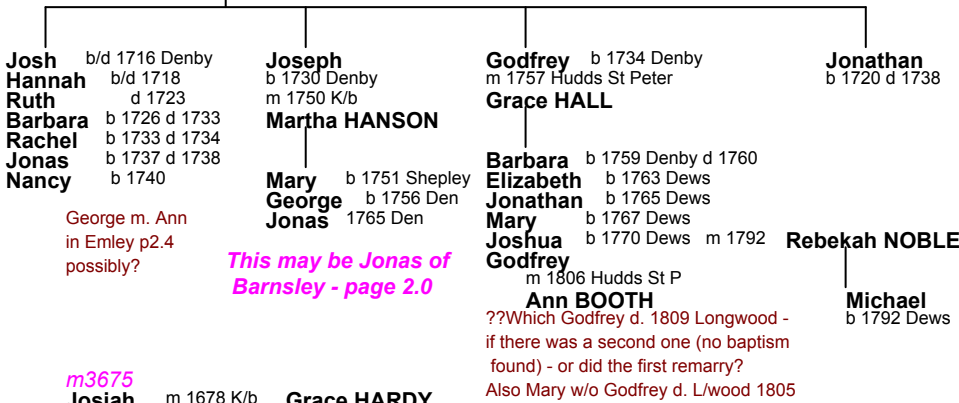

George m. Ann in Emley p2.4 possibly?

This may be Jonas of Barnsley - page 2.0

### Which Julia married William TYAS - below or p1.5

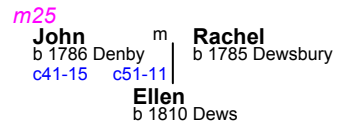
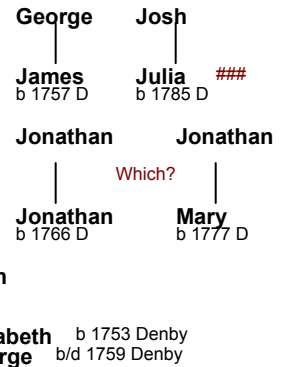

**Richard** **JM1835** of Water Hall (different from K/b) may be son of Josiah <<<

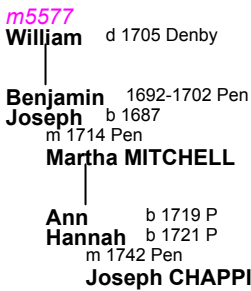
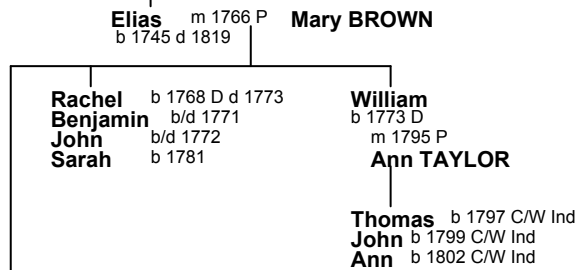
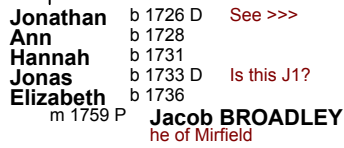
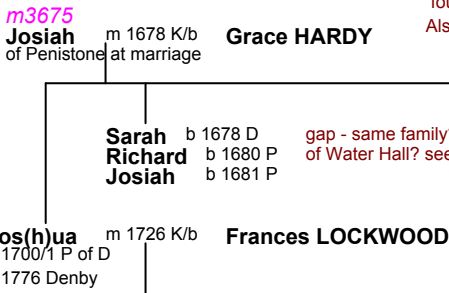
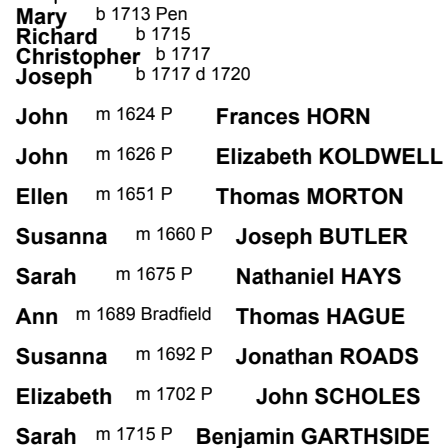

Joseph m. Martha the same place/day that a Sarah M. m. Thomas Charlesworth

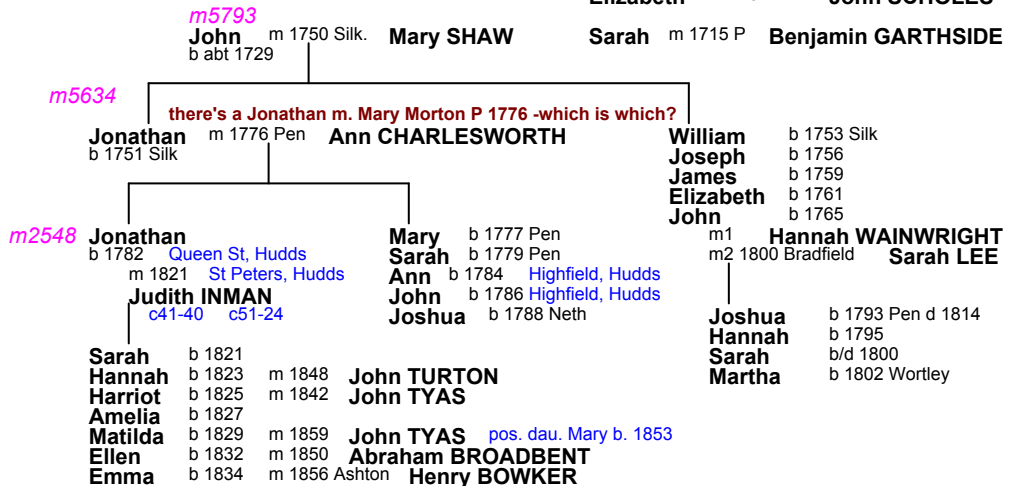
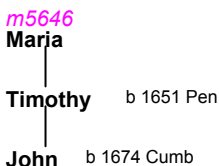

John b 1742 Pen  
m1 1764 Bradfield  
m2 1776 Sheffield

Sarah NORTON  
Martha BOLSOVER

Ann b 1776 Sheffield  
Josias b 1778 m 1807 Darfield  
John b 1780  
Mary b 1782  
Abraham b 1785  
Elizabeth b 1789  
John 1791-2  
Benjamin b 1787  
m 1813 London

Elizabeth WALTON

John b 1808 Sheffield  
James Walton b 1810  
Ann b 1812  
Charlotte Augusta b 1817  
Arthur b 1815 d 1889  
m1 1839 Sheffield m2 1871 Ware  
Mary ? Harriet CONSTANCE  
May or Greensmith

Louisa ELLISS  
Louisa b 1815 London  
John b 1816 Sheffield  
Harriet b 1822 Sheffield  
Benjamin b 1824 Sheffield

William b 1841 Sheffield

Josias 1755-1826  
m 1780 Laughton en le Morthen  
Hannah HOBSON

John b 1782 d 1800 Sheffield  
Mary b 1783 Sheffield  
Elizabeth b 1785 d 1798  
Ann b 1787  
Jonas b 1789 d 1857 m 1829 Rotherham  
Sarah b 1792  
Benjamin b 1795  
Hannah b/d 1796  
Abraham b 1797  
Martha b 1798  
Josiah b 1800  
William b 1804

Maria HEAL

### John's Denby, Penistone and Cawthorne branches

from John's trees - where I don't have the info I've shown them in Blue

JM1831C Eleanor m 1658 K/b William HIRST  
JM1831K Sara m 1648 Eckington George SAVIGE  
JM1831M Unk m Timothy COLDWELL  
JM1831 Josias m 1675 Wors Mary TOTTERINGTON

JM1831N Elizabeth m 1660 W/f Timothy MILNER  
JM1831G Alice m 1668 P William MOORHOUSE

There are wills which strongly suggest that these 7 are siblings - but their parents are as yet unidentified.

John 1676-7 Caw

JM1027 Daniel m 1673 Sara STURTEVANT  
d 1697 P

JM1025C Mary m 1603 P Thomas Wainwright

JM1027B John b 1674 P d 1735/6 P m1 Rachel  
m2 1707 Blyth  
Mary JENKINSON

JM1025 Richard d 1683  
Sister Mary is mentioned in Richard's will but the dates look a bit funny - looks like Richard's sister wasn't the wife of Thos. W.

Lydia b 1696  
Maria b 1698  
Daniel 1700-1  
Sarah b 1702  
Rachel b 1704

Elizabeth b 1708 m 1730 Shef John WAITS  
Jenkinson b 1712  
John b 1716  
Olivia b 1719 m 1750 P William SMITH  
Penelope b 1721  
John has this Olivia m. Wm. but there's also Olivia d/o Samuel p1.6

Susannah b 1675 P  
Elizabeth b 1679 P m 1711 Caw  
Joshua TWIGG

Richard b 1626 Caw  
Jonas 1628-9  
Jonas 1630-3  
Joseph 1632-61 m 1658 Caw Sara CLAYTON  
Martha b 1635  
Sarah b 1638  
Elizabeth m 1663 Emley Nicholas WALSHAW  
Elizabeth Jonathan JM1025N  
Is this JM600 in Hemsworth?

JM500 Josiah d 1672 Caw m 1659 Caw Elizabeth BOWER

JM500B Jonathan b 1660 Caw m 1701 P Martha RICH  
Rachel b 1702 Caw  
Martha b 1705  
Jonathan b 1708 Caw  
Sarah b 1708

JM500C of Flockton and Denby Hall  
Elias b 1661 d 1732 m1. Unk m2. 1702 m3. 1705  
Sarah BEDFORD  
Maria WORDSWORTH

Hannah b 1667 Caw  
Josiah b 1670 Caw d 1725 Silk d. 1725 so not m5590 p1.6

John b 1687 Th d 1740 Fel m Mary HEATON  
JM505 of Hodroyd - offspring bap. Felkirk

Anna d 1692 P  
Elizabeth b 1693 P m George RAGG  
Thomas d 1695 P  
Maria b 1696 P  
Jonathan b/d 1700 P  
Mary b 1697 m 1722 W/f Thomas SWIFT

Sarah b 1703 m 1730 Barnabus WRIGHT  
Hannah b 1706 m Michael CULLE  
Ruth b 1709 m 1733 P Samuel HORN  
Susannah b 1716 m 1737 P Matthew CLARK  
Barbara b 1719



# John's Ingbirchworth branch

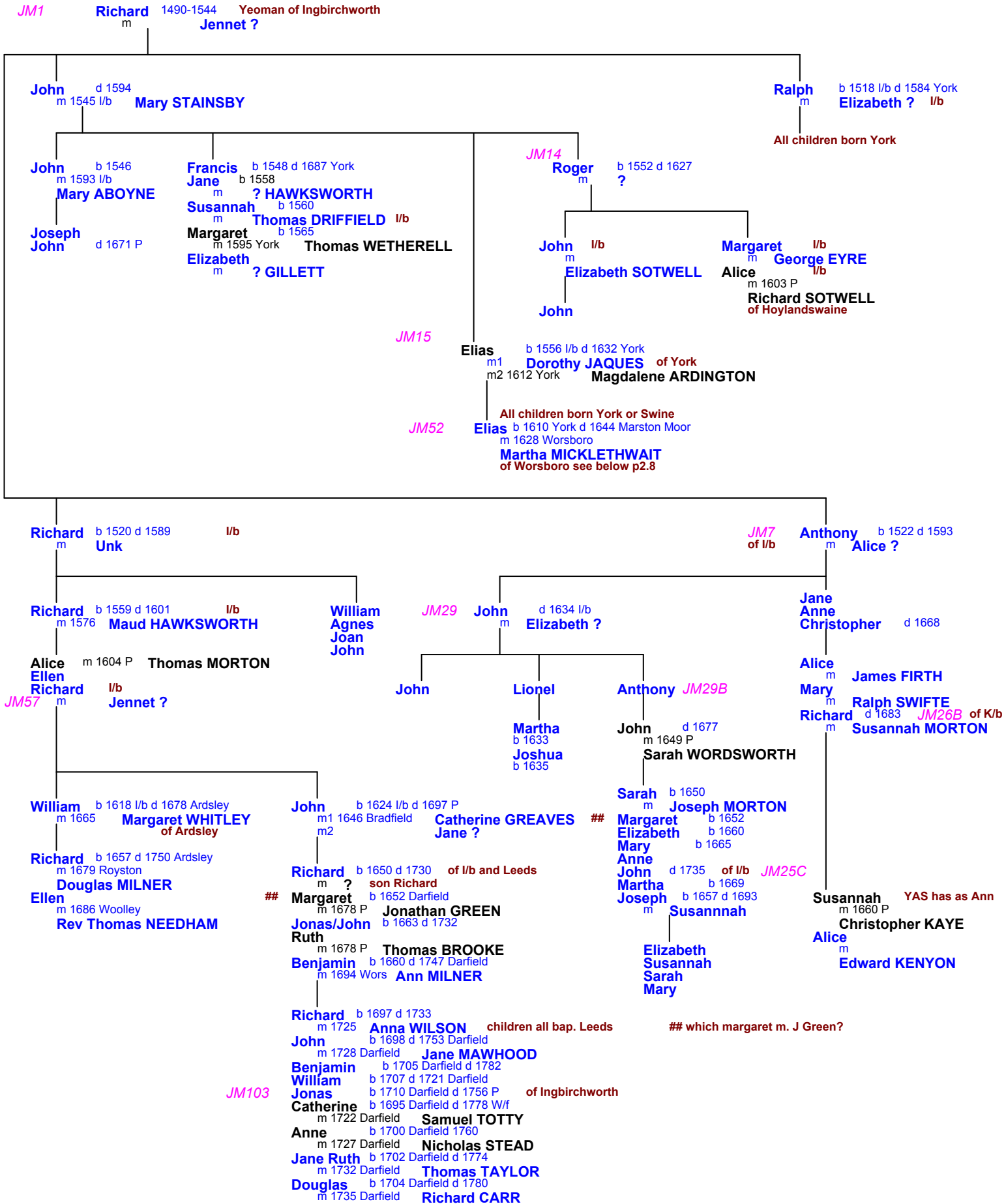

m2176

**Jonas** m 1786 Darfield **Mary BROWN** *I think Jonas is son of Joseph of Denby p1.6 Geoff thinks otherwise*  
 d 1794

**Joseph** b 1786 Darfield **Hannah** b 1789 Darfield  
 m 1806 Silkstone **Elizabeth** b 1791 Darfield  
**Elizabeth COOKE** m 1813 Darfield **George OWRAM**

**Jonas** b 1810 **William** b 1808 Darfield  
 m 1835 Royston **Ann** b 1813  
**Fanny MOODY** **George** b 1815  
**Ann** b 1817 Silkstone

**John** b 1836 Smithies **Joseph** b 1837 Smithies **Harriet** b 1839 Monk Bretton  
 m **Hannah ?** m **Mary A ?** **Sarah** b 1841  
**Eliza** b 1882 Worsboro Dale  
**George** b 1858 Smithies **Jonas** b 1865 **Harriet** b 1867 Smithies  
 m 1877 **Jane MACK** **Rose A POTTER** **Joe** b 1875  
**Leah** m 1896 **Harriet**  
**James** b 1879 Barnsley **Percy** b 1896 Barnsley  
**Vincent** b 1882 **Harriet** b 1896  
**Joseph** b 1883 **Mary** b 1897  
**Lily** b 1885 **Elbie L** b 1899

**George** b 1844 Darton *aka Wes* **Martha** b 1846  
 m 1865 **Esther LAYCOCK** **Julia** b 1849 m 1867  
**Walter** b 1867 Smithies **Myra** b 1874 m 1896 **Hannah** b 1851  
 m 1887 **Frederick** b 1877 **Ellen** b 1855  
**Elizabeth INGHAM** **Charles** b 1879 **Eliza** b 1861  
**Laura** b 1886 Barnsley **Emma** b 1881 **Tom** b 1857 Smithies  
**Ruth** b 1890 **Arthur** b 1886 **Ann ?**  
**Annie** b 1891 **Ernest** b 1886  
**Joseph** b 1894 **Eliza** b 1889  
**Alice** b 1893 *but whose daughter?*

**Vincent** b 1819 Dodworth **Charles** b 1821 Barnsley **Mary** b 1824 Worsboro  
 m 1839 **Ann HODGSON** **Sarah ?** **Anna** b 1826  
**Charlotte** b 1843 m 1864 **Harriet** b 1842 **John** b 1828  
**William** b 1845 **Alice** b 1852 **Elizabeth** b 1830  
**Elizabeth** b 1849 **Ann** b 1854 **Martha** b 1833  
**Mary** b 1850 **Sarah** b 1856 **Sarah** b 1835  
**Emma** b 1859  
**John** b 1849  
 m 1866  
**Annis E OATES**  
**Alice** b 1870  
**Laura** b 1871  
**Emma** b 1873  
**Mercy A** b 1877  
**John W** b 1879  
**Annis** b 1888  
**Esthel** b 1892  
**Charles** b 1875  
 m  
**Isabla**  
**John W** b 1899  
**Ernest** b 1899

**Jonas** b abt 1793 d 1853 Conisborough  
m 1815 Darfield

**Martha GLOVER**

**Vincent** b 1817 Darfield d 1897  
m 1841

**Ann SHAW**

**Sarah** b 1850 Ecclesfield  
**Anna** b 1852  
**Vincent** b/d 1854

**Charles** b/d 1816 Darfield  
**Thomas** b 1819  
**James** b 1821 d 1856  
m 1844

**Ann MASDIN**

**Martha** b 1845 Ecclesfield  
**Elizabeth** b 1847  
**Sarah** b 1849 **Ann** b 1871  
**John** b 1851 d 1853  
**Frederick** b 1853 d 1872  
**Fanny** b 1855  
m 1876 **John CHARLESWORTH**

**Henry** b 1859  
m 1881  
**Mary A MOTTRAM**

**Annie** b 1872 Ecc. d 1884  
**Gertrude** b 1882  
**Arthur H** b 1883  
**Elsie** b 1886  
**Fred** b 1888  
**Willie** b 1890  
**Ernest** b 1894  
**Winnie** b 1899

**Thomas** b 1852  
m 1888  
**Sarah A THORPE**

**John T** b 1887 Wincobank  
**Fred** b 1888  
**Henriette** b 1892  
**Maria** b 1900

**Charles** b 1823 Darfield  
m 1845

**Julia HOWSON**

**Joseph** b 1846 Shire Green  
**Emma** b 1849  
**Matthew** b 1853  
**Mary A** b 1855  
**William** b 1888  
**Henry** b 1860 d 1865  
**George** b 1861

**Mary Ann** b 1825 Darfield  
**John** b 1827  
**George** b 1830 d 1832 Con  
**William** b 1832 d 1832 Con  
**Thomas** b 1832 d 1832 Con

**Joseph** b 1827  
m 1854  
**Eliza Jane ENDERBY**

**Charles** b 1865 d 1876 Utah

Joseph and family emigrated to Utah 1869

## Manchester

m4913

**William** m **Mary Ann**  
b 1797 "Yorkshire"

**Elizabeth** b 1820 Manc  
**John** b 1822  
**Thomas** b 1824 Chorlton  
**Mary Ann** b 1827 Manc  
**Maria** b 1833  
**William Henry** b 1830  
m 1853 Manc  
**Emma WRAY**

**Sarah** b 1853 Rochdale  
**Frank** b 1855 Manc

**Elizabeth** b 1862 Rochdale  
**Frank** b 1864

m 1886 Rochdale  
**Harriet LORD**  
**Walter** b 1857  
**Arthur** b 1862 Rochdale  
m 1880

**Rebecca HUGHES**

**Lilian** b 1882 Rochdale  
**Emma** b 1883  
**Annie** b 1887  
**Frank H** b 1889 Manc  
**Edith** b 1898 Rochdale

**Paddock**

It is not yet certain that John was the son of Daniel and Sarah - it seems most likely given the use of the name Henry which rarely appears outside of the D21 branch. Other candidates are Godfrey of Dewsbury (page 1.6 and Samuel of Kirkburton (Page 2.3)

son of Daniel and Sarah - see p1.4

**John** b 1805 d 1849 *a1*  
 m **Hannah MITCHEL** b 1803

c51-4 Paddock (Hudds) and other sources

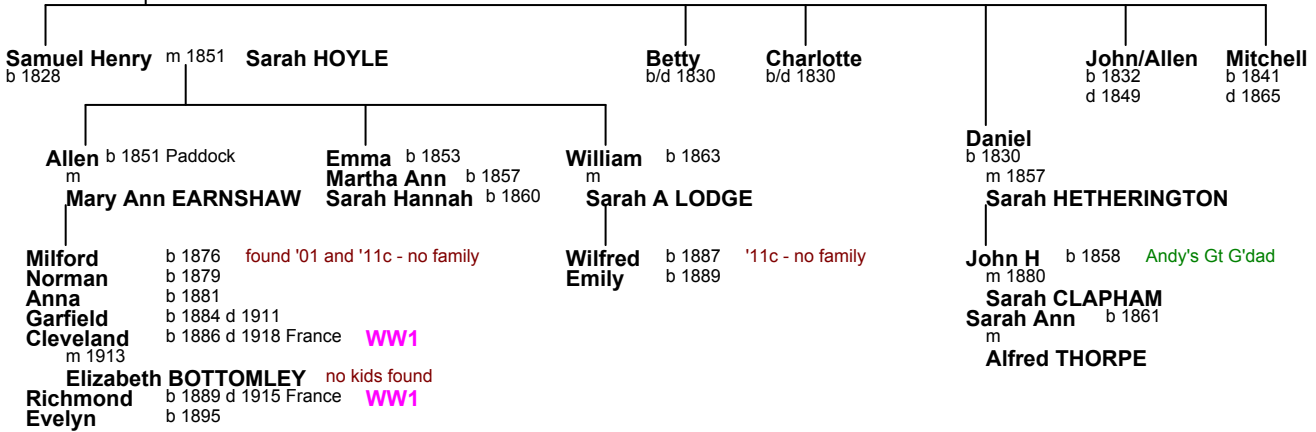

**Others**

IGI Rochdale

**Elizabeth** m 1669 **Samuel DEWHORST**

Kirkheaton

**Daniel** m 1778 K/h but res M/f. d 1782 *m2507*  
 m **Sarah OLDROYD**  
 ?Mary O. m. James above p1.1?  
 It is possible Sarah was the widow John Copley married (p1.2)

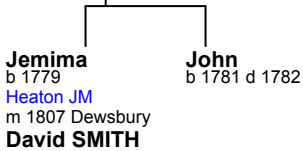

Flockton

**Thos** m **Mary** *m6243*

**Nancy** b 1805  
 Flockton Zion

BVRI Sandal Magna

**James** m 1608 **Izabell KAYE**  
 I can't see James on any tree

St Peters, Hudds

**Susanna** m 1691 **Humphrey CROSLAND**  
**Jonathan** m 1801 **Mary STEAD**  
**Ann** m 1822 **Thomas PEARSON**

Dewsbury

**Elizabeth** m 1781 **Joseph CLARK**

**Nancy**

**David** b 1781 M/f

Are these the same?

**David** m **Susannah**

**Ann** b 1803 Dews

Was this David's 2nd marriage? *c41-10*  
**David** m 1814 **Dorothy WEBSTER** *c51-7*

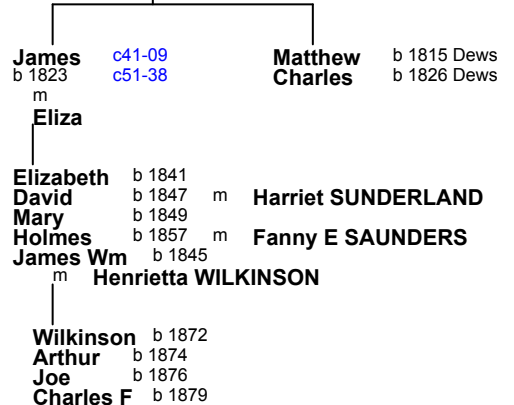

IGI Almondbury

**Jane** m 1819 **Dean SWIFT**

**Martha** m 1832 **Thomas THOMAS**  
 Andy's John was in this same batch - is Martha related?  
 Is she dau. Samuel and Mary of Thornhill?

BVRI Almondbury

**Johannes** m 1600 **Elizabeth LOCKWOOD**

**Sara** m 1725 **Johannes GRICE**

IGI Birstall

**William**

**John** b 1776  
**Jacob** b 1778  
**William** b 1782  
**William** b 1787  
**Sarah** b 1789  
**Betty** b 1792  
**Mark** b 1793  
**Ann** b 1795

**Mary** *m5589*

**Thomas** m b 1804 Dews **Mary Ann**

**Sophia** b 1832 Birstall

# Kirkburton and Fulstone

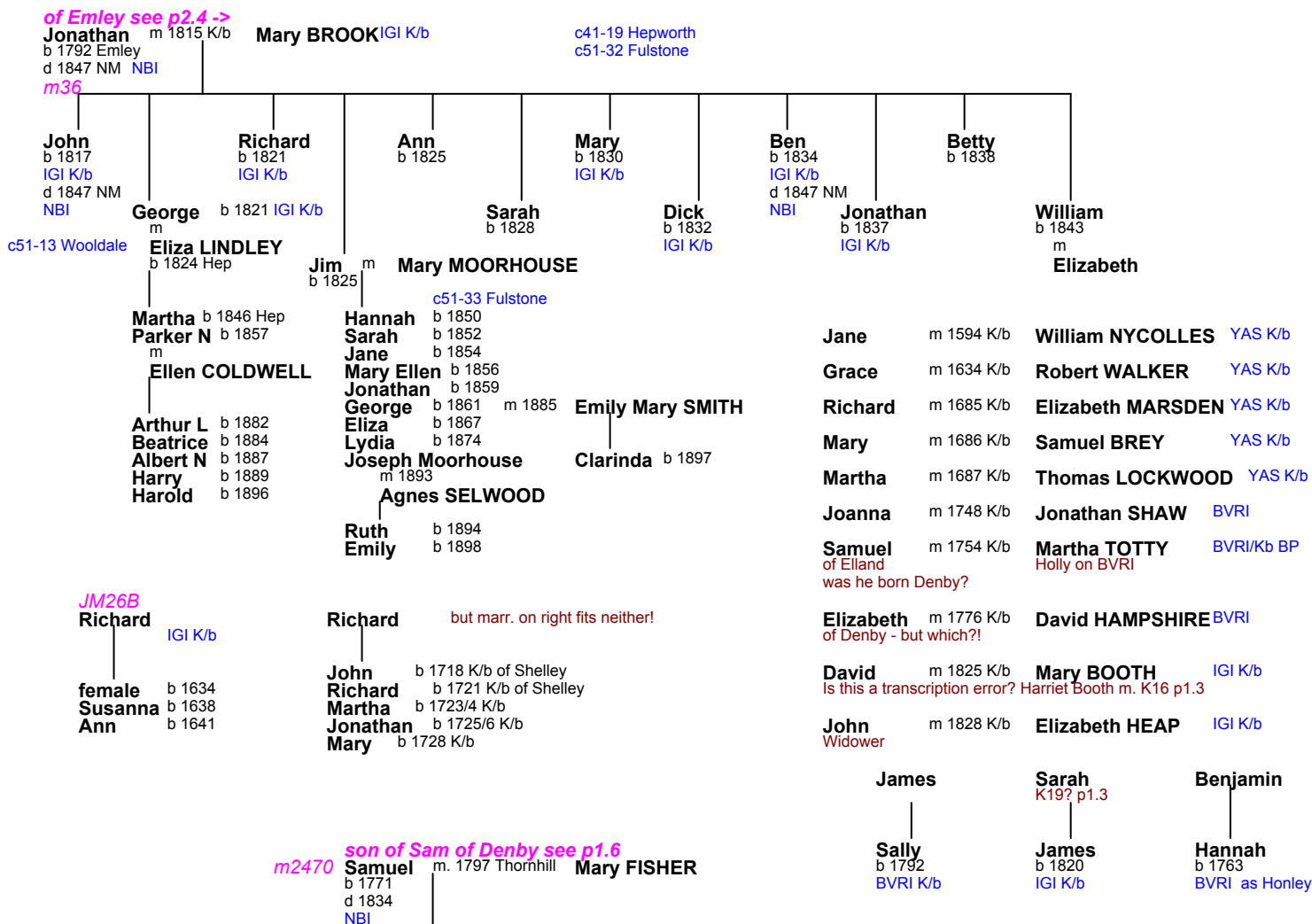

# Fulstone with Cumberworth connections

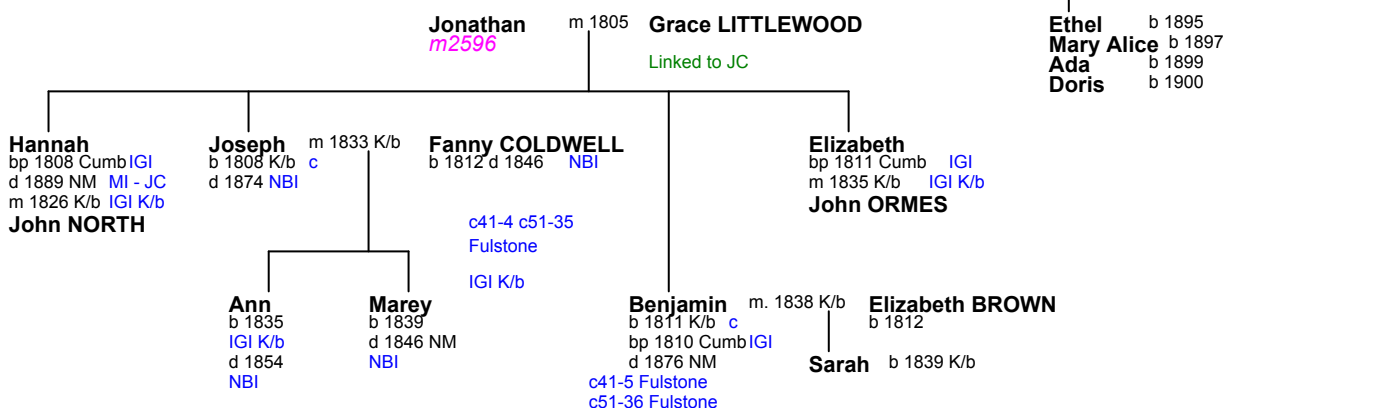

# Emley

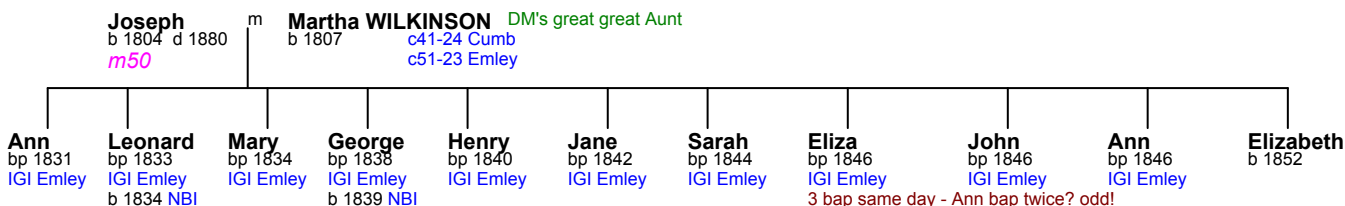
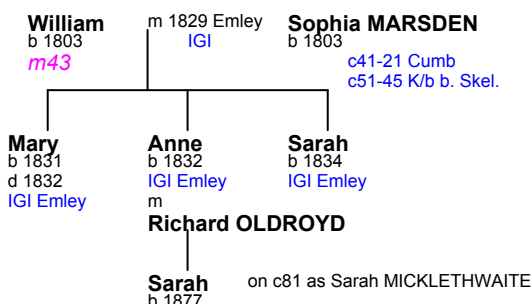
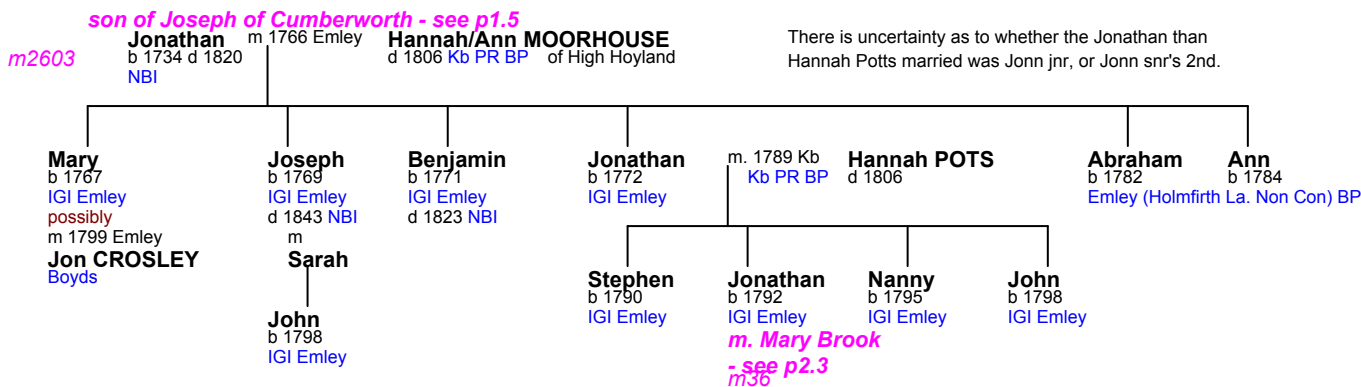

IGI Emley

**Elizabeta** m 1663 Emley **Nicholas WALSHAW**

**Johannes** m 1679 Emley **Elizabeth PARKER**

**Jonathan** m 1754 Emley **Martha FRANCE**

**Susannah** b 1755 H.Hoyland of C/W  
**Elizabeth** b 1757  
**Martha** b 1760

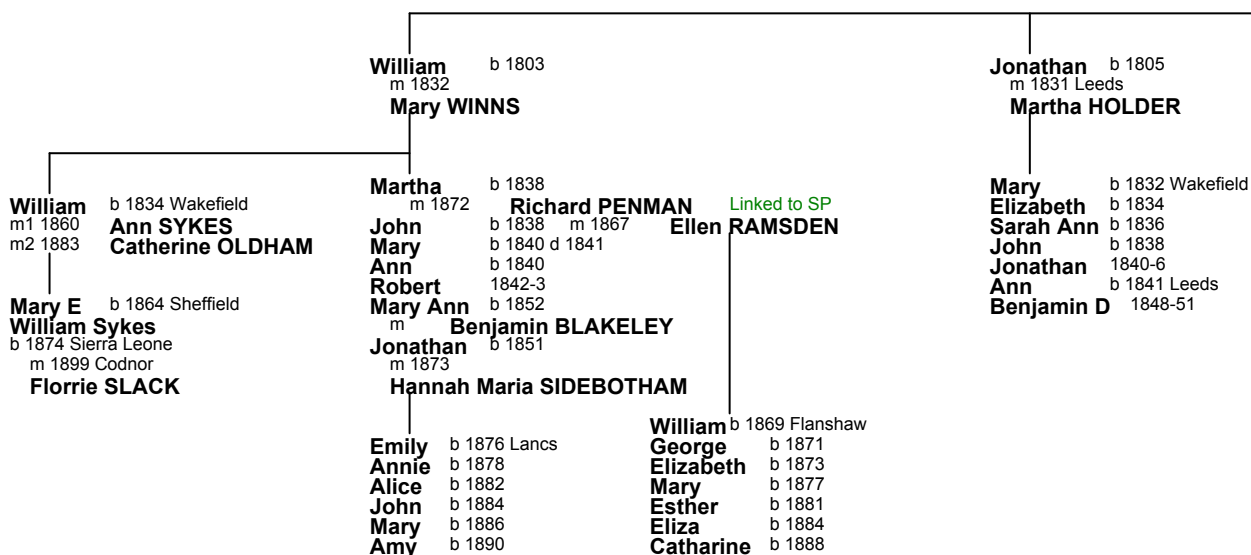

# Thornhill

by Dewsbury

Joseph m1805 Nancy NUTTER  
b 1782 d 1857 c41-32  
m1038

Page 2.5

Joseph probably son of Fanny, dau. of Jonas J1 p1.3

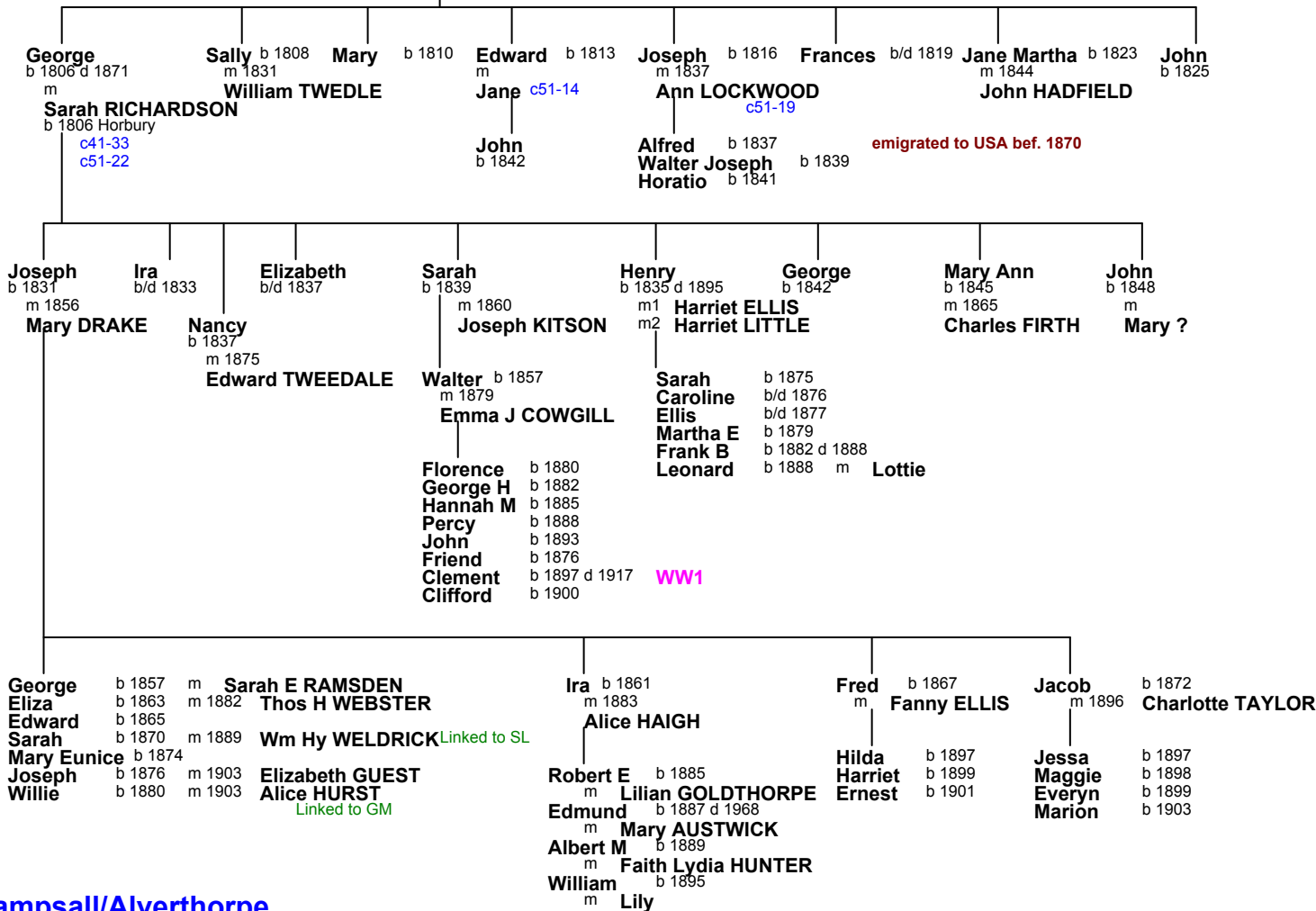

# Campsall/Alverthorpe

m5934

Jonathan m 1751 Campsall Martha KITSON  
d 1762 Campsall

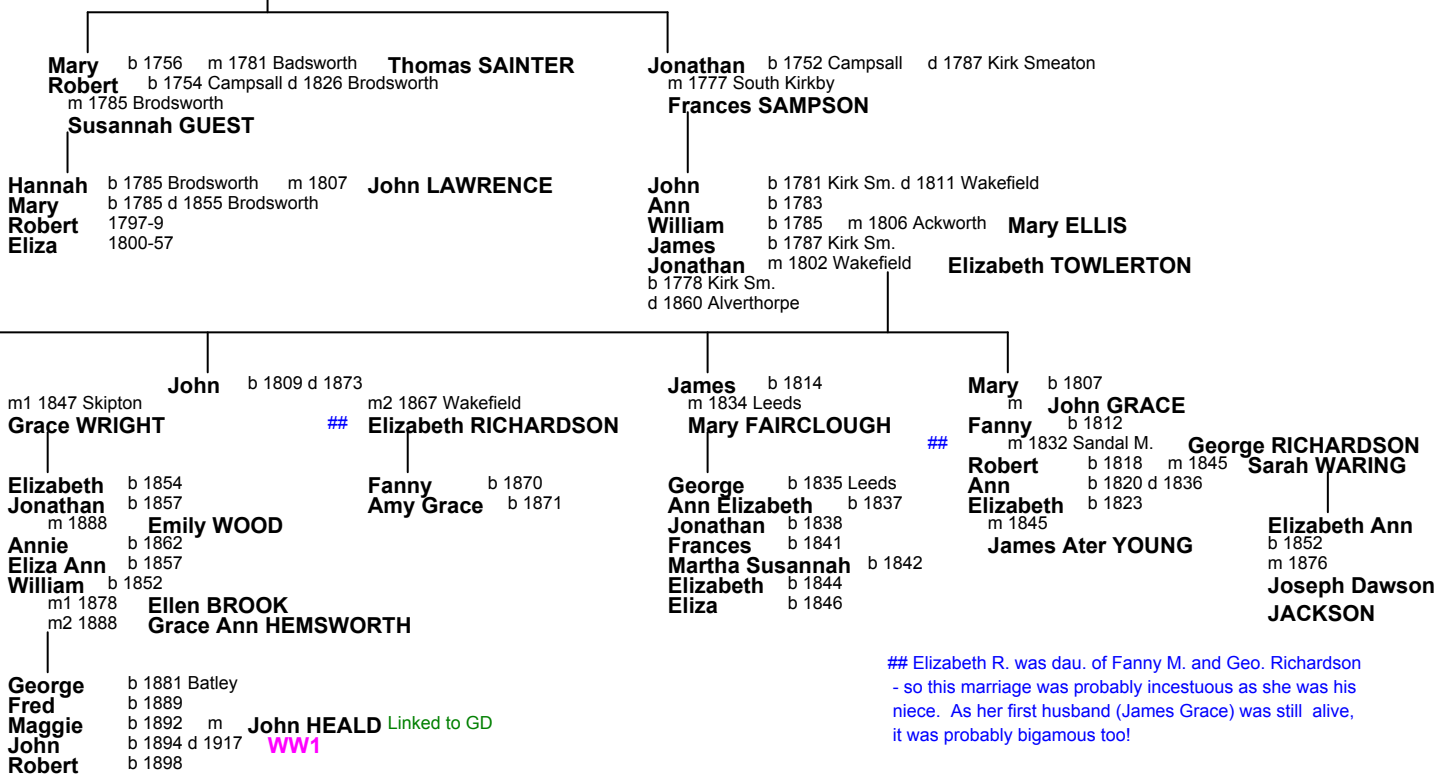

# Elizabeth R. was dau. of Fanny M. and Geo. Richardson - so this marriage was probably incestuous as she was his niece. As her first husband (James Grace) was still alive, it was probably bigamous too!

\*\* Eliza Ann was dau. of Elizabeth Richardson and James Grace but living with and as a Micklethwaite in 1871

**James** m1153  
b 1778 Cumb.  
m 1798 Hoyland  
**Hannah DARLEY**

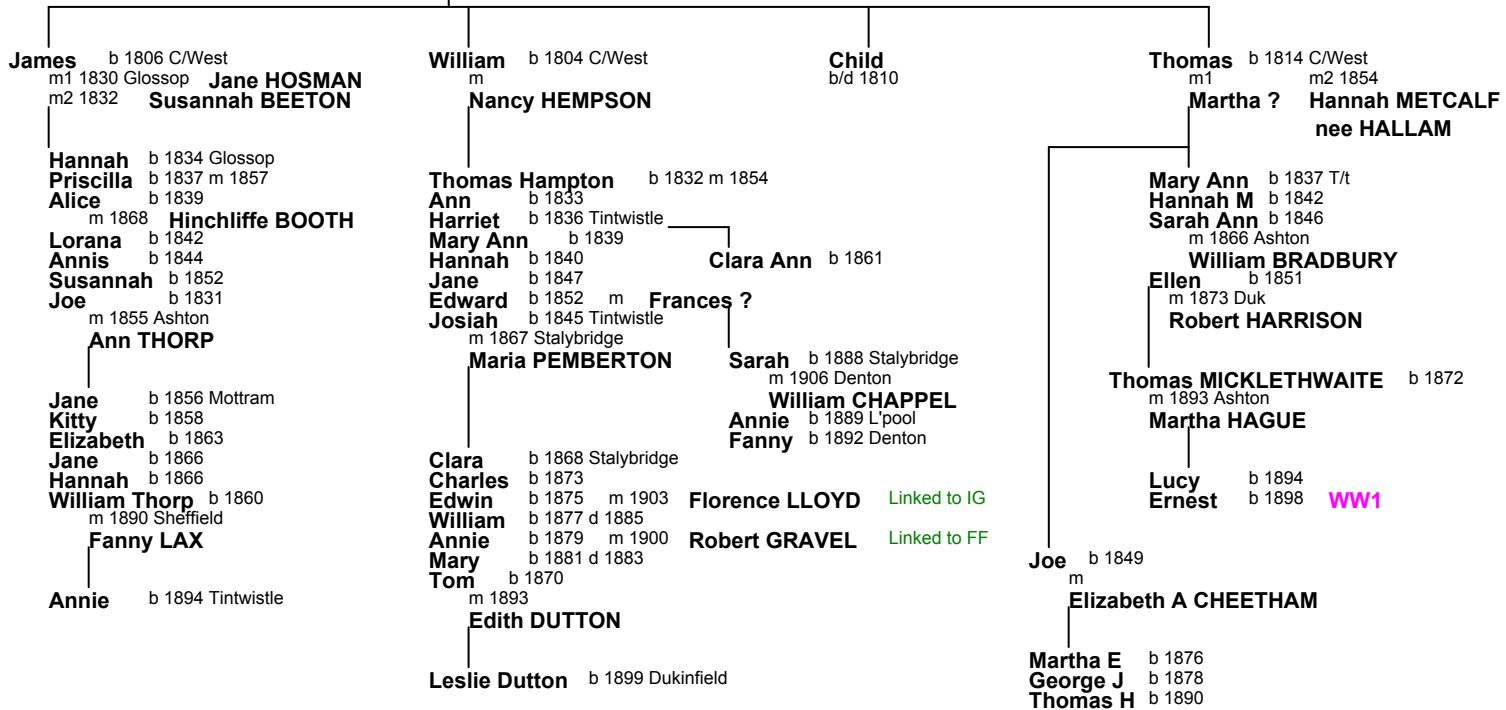

Saddleworth originally

**William** m 1811 Sadd. **Ann BARTON**  
m4245

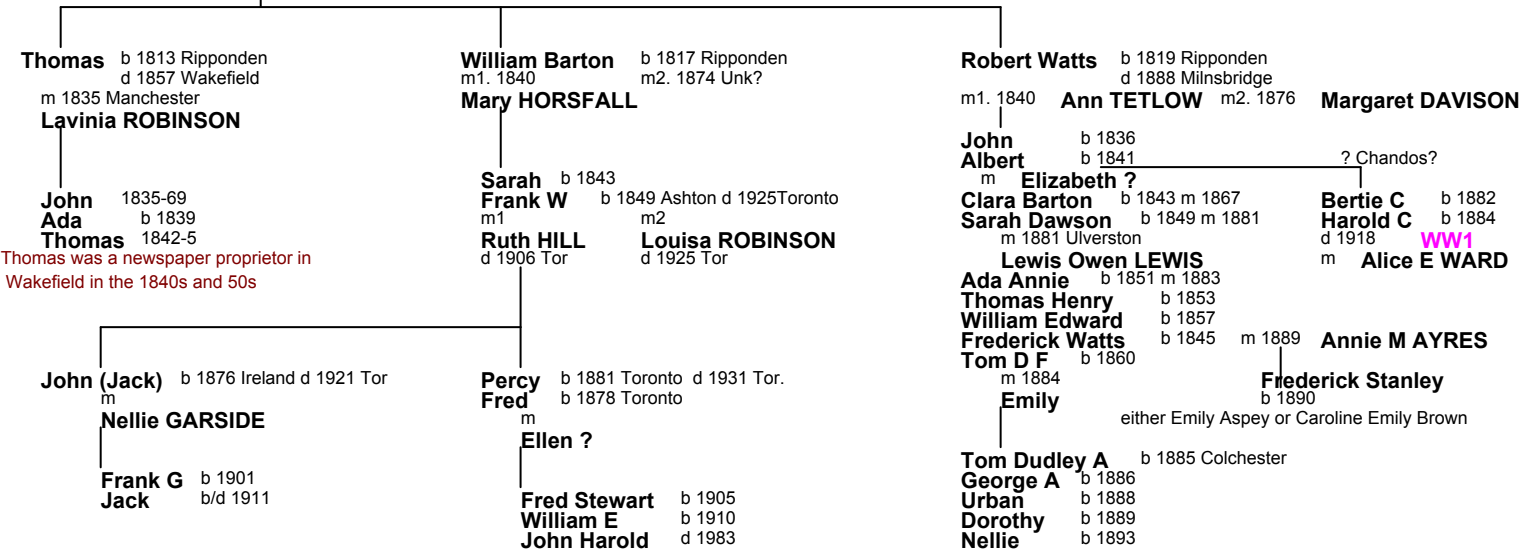

F W was a famous Canadian photographer  
- "his business was carried on by eldest son Fred, and his son John Harold" (acc. Wiki)  
although the 81c shows John as eldest

Canadian 1901c: <http://automatedgenealogy.com/census/Province.jsp?province=ON>  
Canadian 1911c: <http://automatedgenealogy.com/census11/Test6.jsp?province=Ontario>



# Emley, Alverthorpe and Thornhill

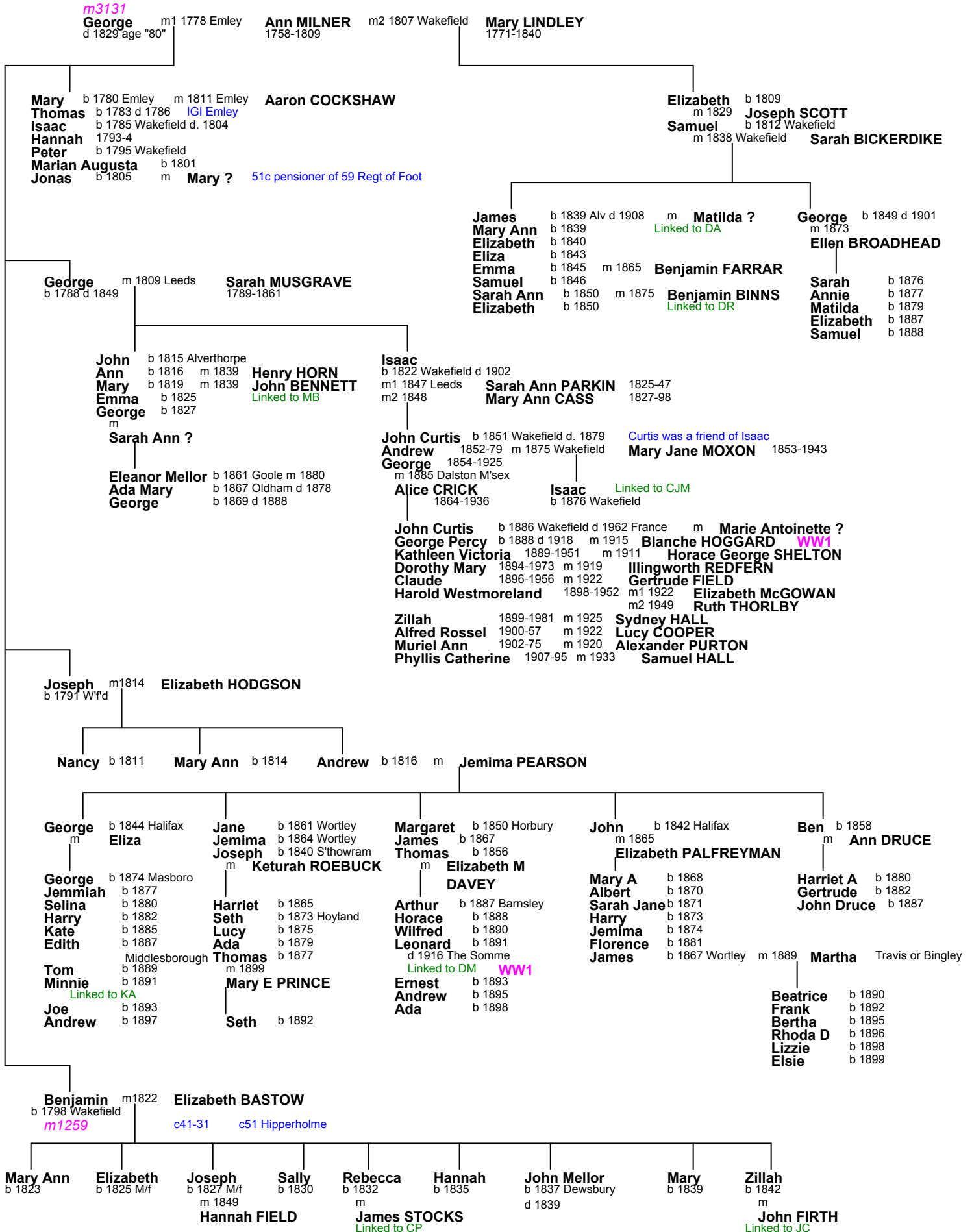

# John's Worsborough and Hemsworth branches

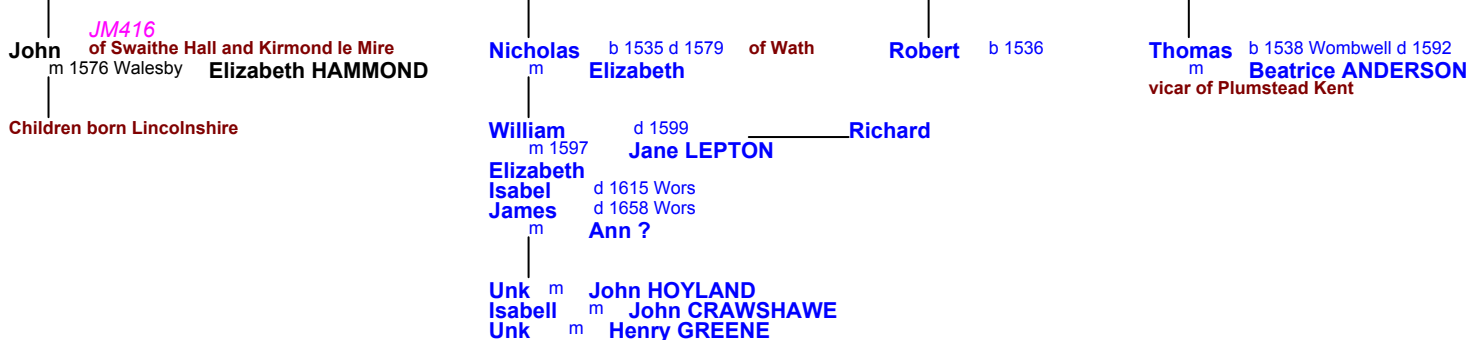
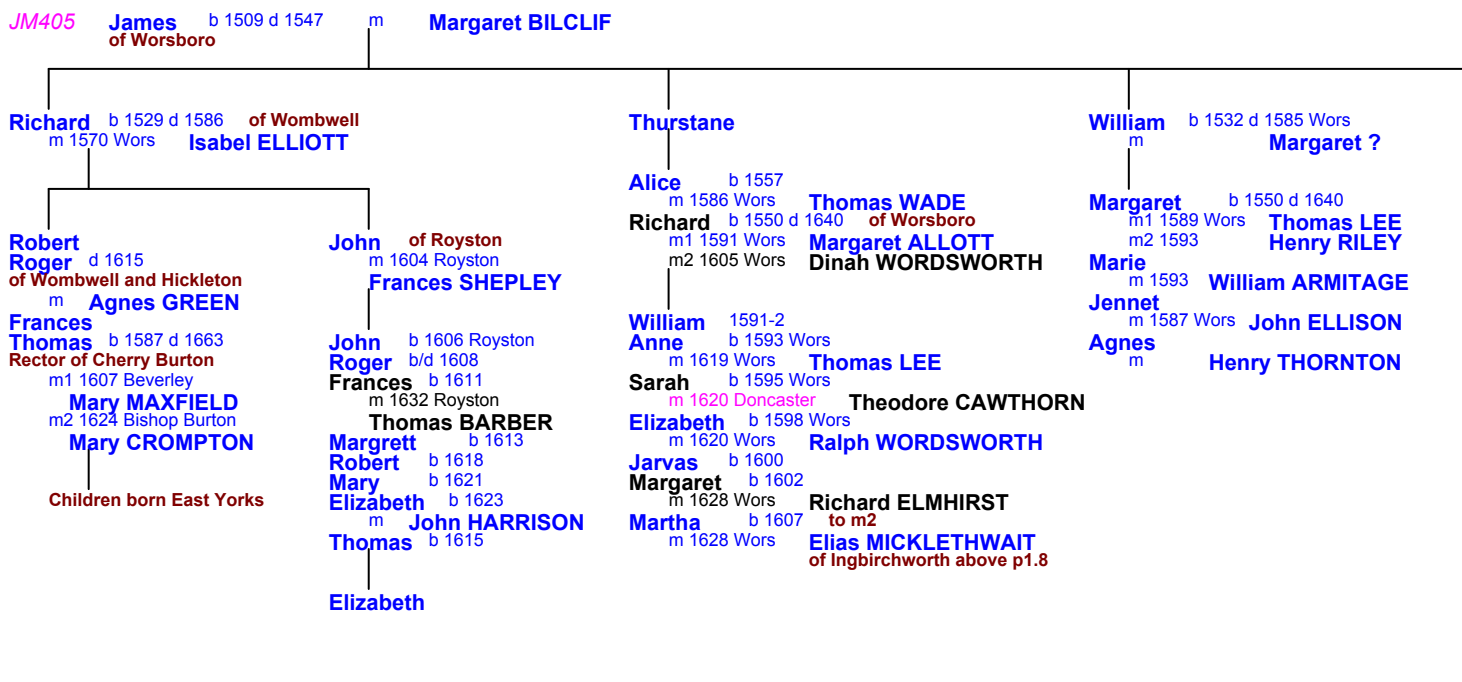

**JM600**

